

The Core Family

The Core family line offers a rich diversity of technical and aesthetic options. Our 3" fixed square offers 14+ finishes & custom wood choices. A wide range of source/optic selections, 3 ranges of Ambient Dim™ (Warm Dim), 5 beam spreads, and a multitude of driver/control options including TruPhase™ (phase dimming down to 0.1%). Our Core product family is created on platform allowing for a high degree of modification.

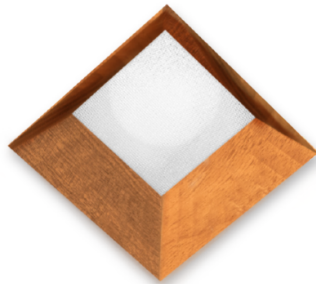
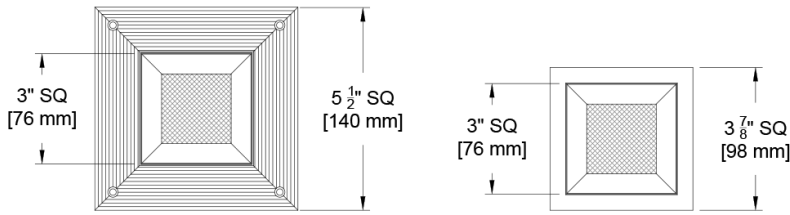
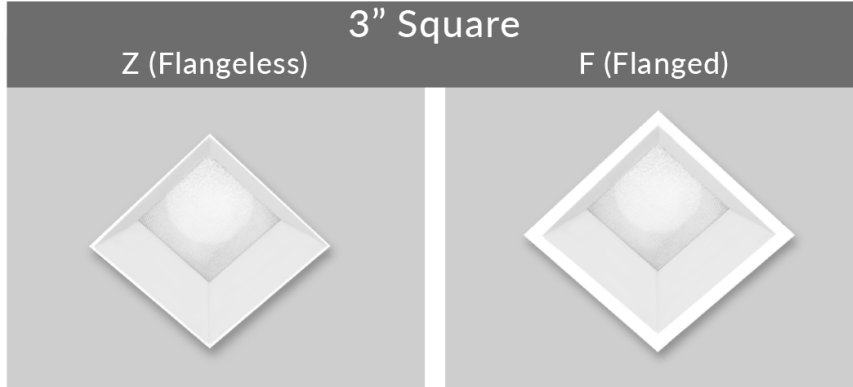

Wood Finish Available

PROJECT:

TYPE:

SPECIFIER:

DATE:

Key Points (CR3D-SF)

Trim

- One-piece die cast aluminum or machined wood trim
- Flangeless includes plaster flange with lip
- 14 color options + custom RAL or wood available
- Flanged or Flangeless

Source / Optics

- 2400K, 2700K, 3000K, 3500K, 4000K
- AmbientDim™, RGBW & Tunable White options
- 90 CRI, 55+ R9 Standard 95 CRI 90+R9 Optional
- <2 MacAdam Steps (<2SDCM) for fixed white
- Up to 1862 delivered lumens
(Based on 3000k CCT @ 90+ CRI)
- 5 beamspreads available- 10°, 15°, 24°, 36°, & 50°
- [View Photometry](#)

Housing

- Compliant to with Airtight Housing
- Listed – Damp or wet with shower trim
- Approved for 8 (4-in / 4-out) #12 AWG conductors rated for 90°C through wiring
- IC Rated / Airtight Housing approved for use in direct contact with insulation – Chicago Plenum Available
- Heavy gauge steel for new construction or remodel

Driver

- TruPhase™ - Dim to 0.1% - 120V only
- 0-10, DALI-2, DMX, Lutron or Casambi
- Flicker free to IEEE 1789-2015
- Prewired and integral to housing
- Universal 120-277v

Ordering Codes

PROJECT:

SPECIFIER:

DATE:

TYPE:

QUANTITY:

Ordering Code Example: CR3D-SF-DR-Z-AU-C20-35-24-E2-P16-91A-91L-97L-CP

FIXTURE	APERTURE	TRIM	MOUNTING	SOURCE / WATTS	CCT	BEAM	DRIVER / CONTROL	TRIM FINISH	LENS ACCESSORIES	ACCESSORIES
CR3D-SF	DR	Flangeless Trims	Shallow Housing	C6 * ●● 6W 364Lm 90+CRI, 60+R9	24 2400K	10 Narrow Spot *Only with C6, C8, & C10	C1 0-10 1.0%, UNV (120-277V) linear	W White Paint	Aperture Lens	CP Chicago Plenum
Core 3" Square Fixed Downlight	Deep Regress	Z Flangeless Trim	ASPM ●● Airtight Shallow Panel IC-Rated	C8 * ●● 8W 497Lm 90+CRI, 60+R9	27 2700K	15 Spot	C2 ELV/Triac 1.0%, (120V) linear	B Black Paint	91A Solite	EM Emergency Pack
		ZS Flangeless Shower Trim	ASP ●● Airtight Shallow Plaster IC-Rated	C10 * ●● 10W 580Lm 90+CRI, 60+R9	30 3000K	24 Narrow Flood	E1 0-10 0.1%, UNV (120-277V) log	D Wood*	93A Frosted	Controls
		Flanged Trims	ASU ●● Airtight Shallow Universal IC-Rated	C14 ●● 15W 1397Lm 90+CRI, 60+R9	35 3500K	36 Flood	E2 DALI-2 0.1%, UNV (120-277V) log	PXX Specialty Paint Color*	XXA Other Aperture Lens Treatments*	ATH Lutron Athena Wireless Node Must be used with E2 driver
		FS Flanged Shower Trim	●● Supports California Title 24 compliance to JA8 Requirements	C20 ●● 21W 1862Lm 90+CRI, 60+R9	40 4000K	55 Wide Flood	E3 0-10 0.1%, UNV (120-277V) linear	P01-P15	Reflector (lamp) Media	CA Casambi Wireless BLE to be paired with driver
		F Flanged Trim * Aperture Lens Required		Tunable	Tunable		E4^ DMX 0.1%, UNV (120-277V) Universal DMX Driver/Controller RGBW-DMX ^ INCLUDES DMX/RDM COMPATIBLE DRIVER WITH BUILT-IN DECODER - CONTROLLER BY OTHERS (REMOTE ONLY)	C Custom/RAL Color** 	91L Solite	
				T9 10W 90+CRI, 60+R9 Tunable White	TW1840 1800-4000K Tunable White w/ E1, E2, E3, E4		TR2 0.1%, (120-120V) log TruPhase™ Up to 20W Forward and Reverse compatible Phase Dimming Static White & Ambient Dim only	*Wood "D" Selection to be used with Z trim and PM mounting **See Specialty Finish Guide 	93L Frosted	
				T15 15W 90+CRI, 60+R9 Tunable White	TW2765 2700-6500K Tunable White w/ E1, E2, E3, E4				97L Black Hexcel Louver	
				RGBW 90+CRI, 60+R9 Ambient Dim™	RG1280 1200-8000K RGBW Dynamic Color Changing *Requires E2 or E4				XXL Other reflector (lamp) media* 1 piece of Media per opening (aperture or reflector) can be selected *Refer to Lens Accessory Guide 	
				A14 ●● 15W 656Lm 95+CRI, 90+R9 ●● California Title 24 Compliant to JA8 * Only with 10" optic View Photometry	2722 2700-2200K					

Ceiling Cutouts and Dimensions

Deep Regress shown - other apertures are similar

Square Flangeless Housing

Panel Mount (Z/ASPM)

CR3D-SF-Z-ASPM-

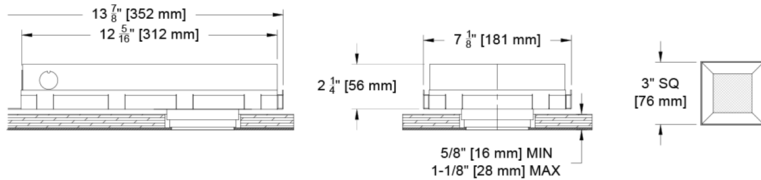

Panel Mount Detail

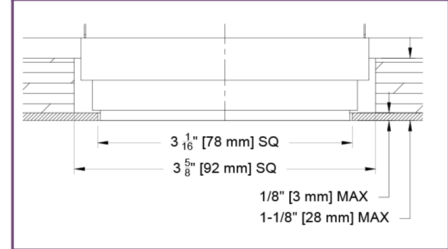

Square Flangeless Housing

Plaster Mount (Z/ASP)

CR3D-SF-Z-ASP-

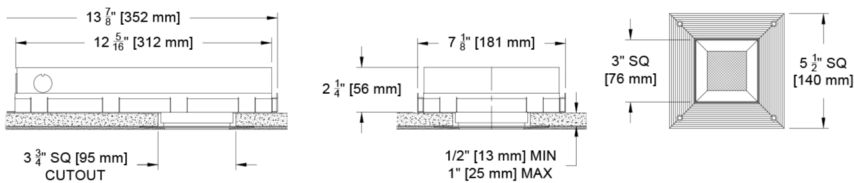

Hanger Bar Detail

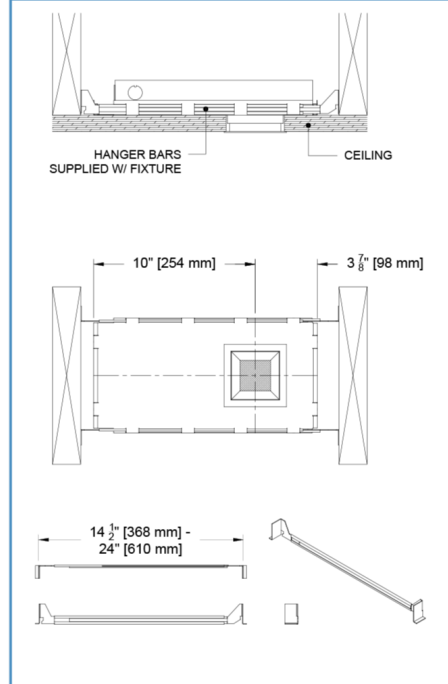

Square Flanged Housing

Universal Mount (F/ASU)

CR3D-SF-F-ASU-

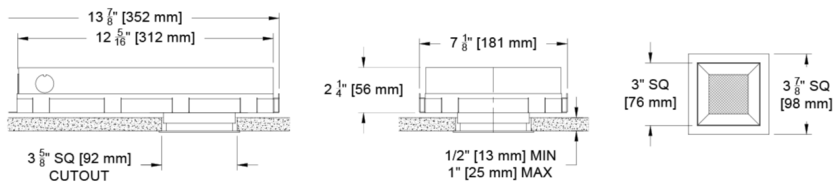

Photometric Table

All data is based from goniometer measurements of production representative product. All lumen values can vary +/- 10% from LED manufacturer rated flux range.

	System watts (W)	10°				15°				24°				36°				50°							
		Del. Lms	Lms/Watt	Peak CD	10% Field	Del. Lms	Lms/Watt	Peak CD	10% Field	Del. Lms	Lms/Watt	Peak CD	10% Field	Del. Lms	Lms/Watt	Peak CD	10% Field	Del. Lms	Lms/Watt	Peak CD	10% Field				
Citizen C6	6	364	63	8326	18°	Not Compatible				Not Compatible				Not Compatible				Not Compatible							
Citizen C8	8	497	60	11368	18°																				
Citizen C10	10	580	54	13266	18°																				
Citizen C14	15	Not Compatible				1297	82	13620	28°	1398	89	7083	41°	1362	87	4162	52°	1368	87	2305	68°				
Citizen C20	20					1723	79	18688	28°	1862	85	9535	41°	1802	83	5492	52°	1822	84	3080	68°				
Ambient Dim A14 - 3019	15					IN PROCESS																			
Ambient Dim A14 - 2722	15																								
Ambient Dim A14 - 3022	15																								
Tunable White - T9	12																								
Tunable White - T15	12																								
RGBW	??																								
	Citizen					10.8°				15.1°				25.1°				33.1°				48.6°			
2700	0.95																								
3000	1.00																								
3500	1.02																								
4000	1.03																								

All Measurements delivered or derived delivered lumens based on 3000K.

Citizen CoB C6, C8, C10, C14, C20

- <3 MacAdam Ellipse (<3 SDCM)

92 CRI 52 R9

92 RF 100 RG

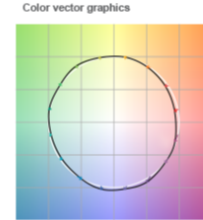
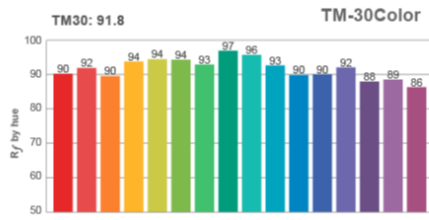
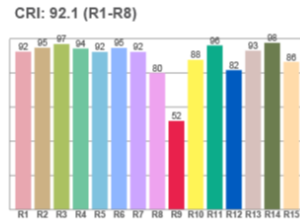

Spectra

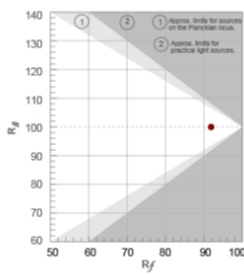
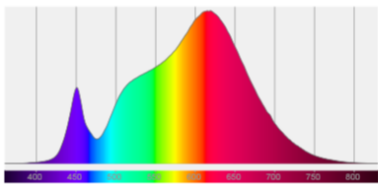

Color distortion

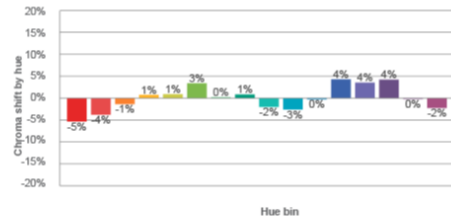

AmbientDim™ A14

- <3 MacAdam Ellipse (<3 SDCM)

3000 CCT Full Output

97 CRI 98 R9 95 RF 104 RG

CRI: 96.9 (R1-R8)

Spectra

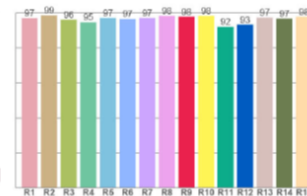
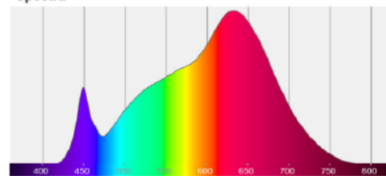

1850 CCT 5% Output

93 CRI 72 R9 83 RF 110 RG

CRI: 92.6 (R1-R8)

Spectra

